

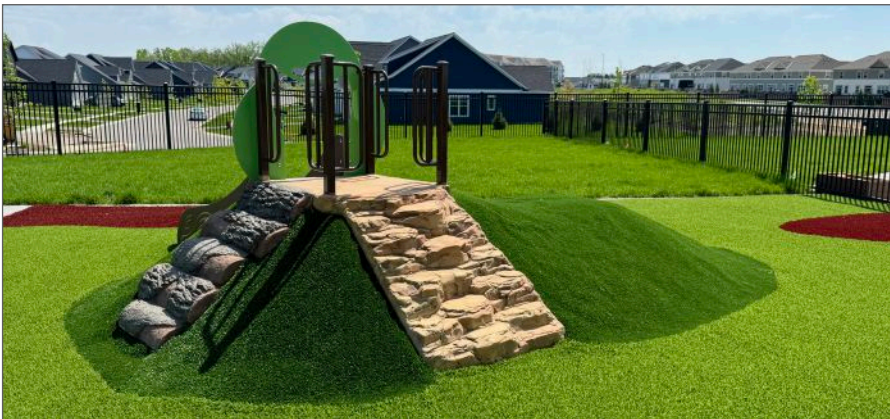

Cre8Play's unique Slide Mound includes 2 climbers and a durable HDPE slide. Specially designed to accommodate either Poured in Place rubber surfacing, (PIP), or Synthetic Turf. Manufactured with a coating of Glass Fiber Reinforced Concrete, (GFRC), for durability and a sturdy base for surfacing. Kids will enjoy running up the mound, climbing and sliding.



L: 15' 4"  
W: 12' 10"  
H: 5' 11"  
1,650 LBS

DOES NOT INCLUDE SURFACING  
MOUND ONLY  
(Appx. 110 square feet of surfacing required)

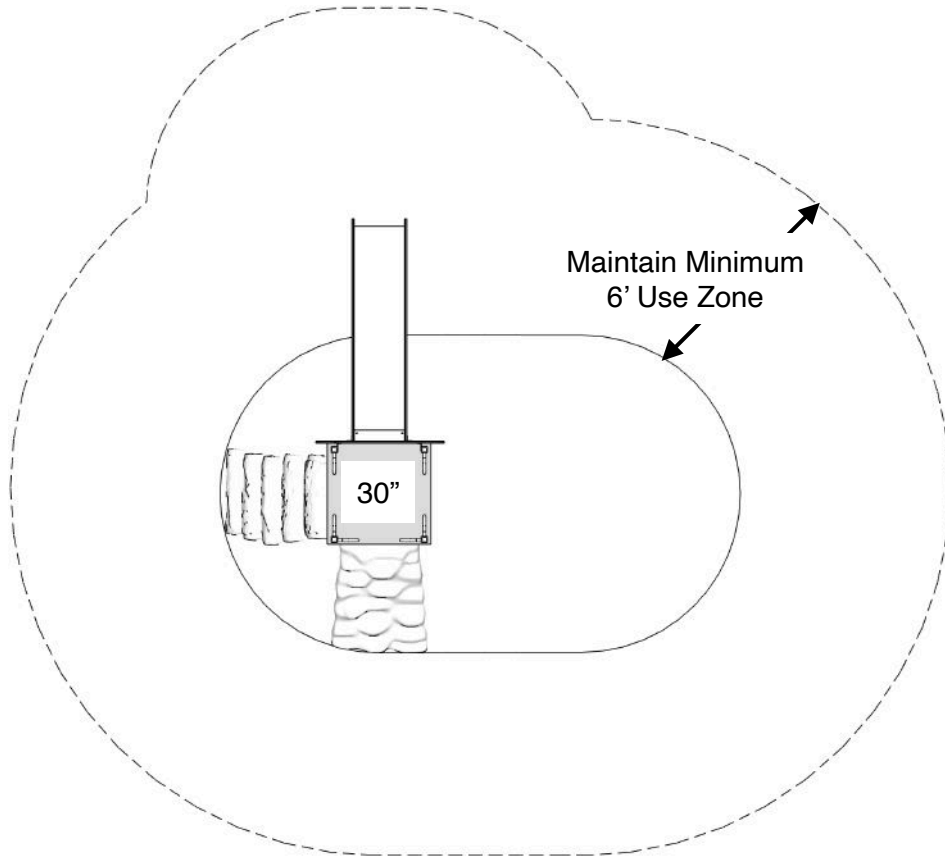

Use Zone:  
27' 6" x 25' 0"

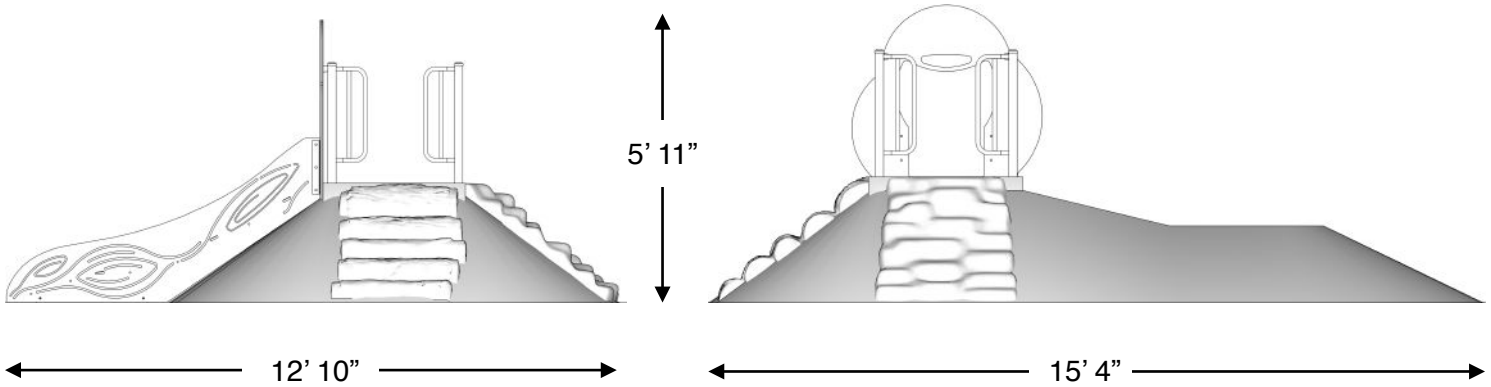

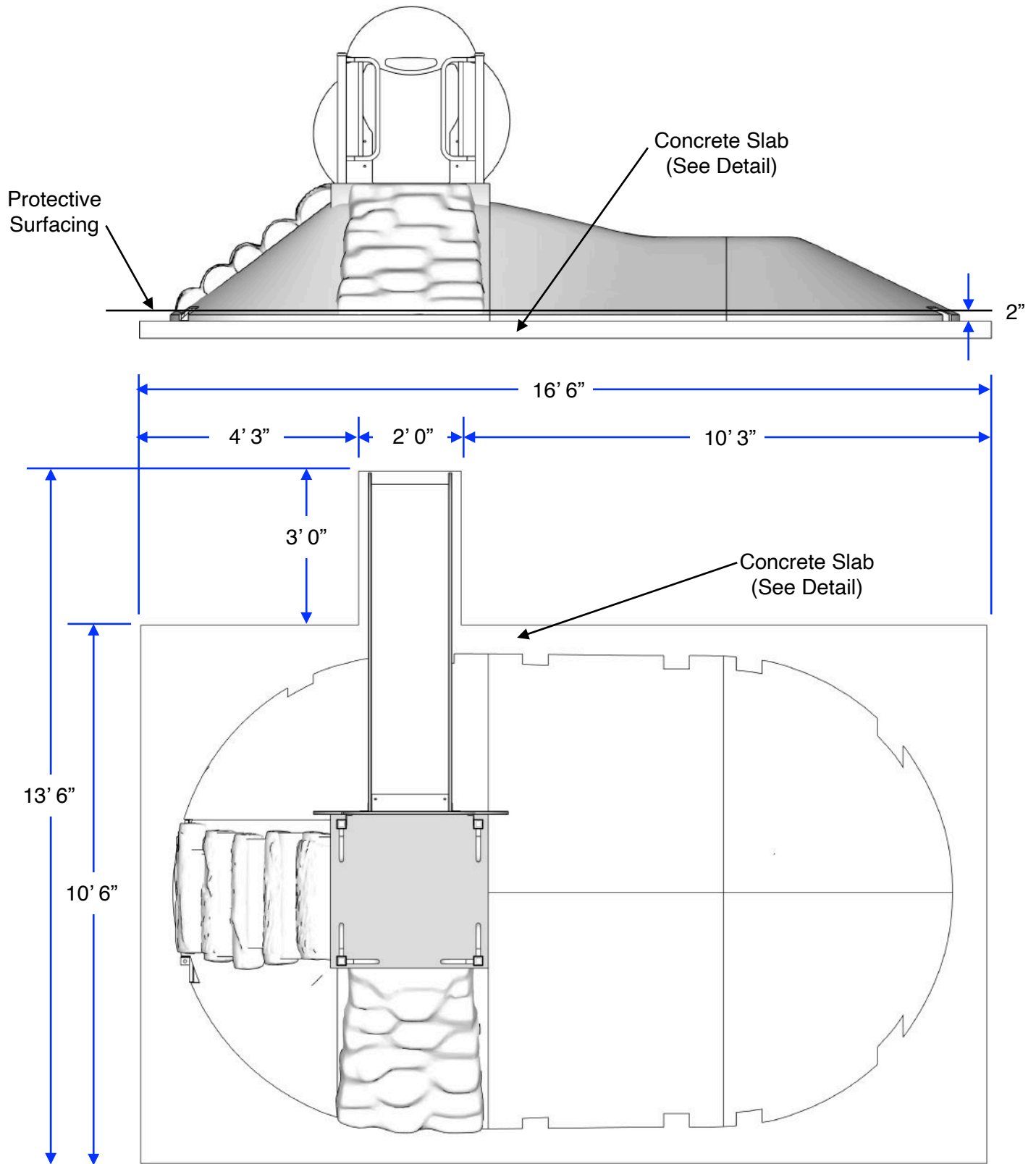

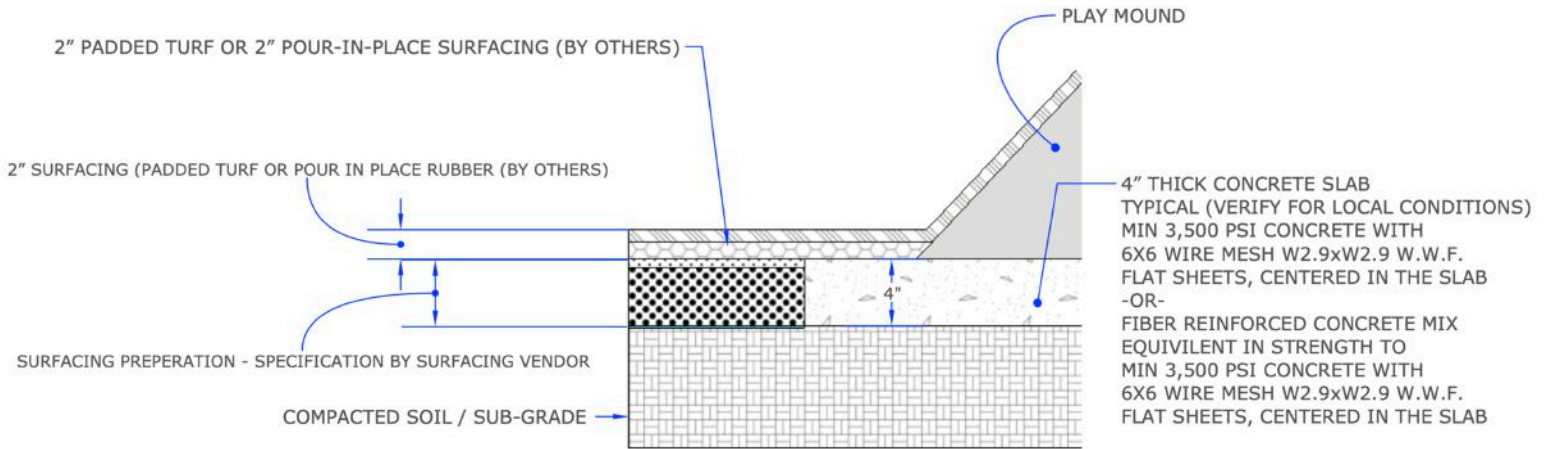

### 4" CONCRETE SLAB SECTION

Check Local Soil Conditions and Local Building Codes

#### NOTES PRIOR TO CONSTRUCTION:

- Use appropriate equipment to lift and move the play equipment.
- Check local codes and requirements prior to digging or installing any equipment.



EXAMPLE OF COMPONENT

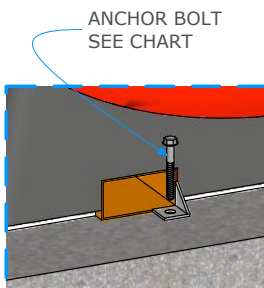

**NOTE: Read installation instructions thoroughly before starting installation process.**

**Step 1:** Lay out the area and prepare the site for install. Concrete must be installed over a solid, level base. Check local soil condition and codes. See product installation instructions for minimum use zone requirements to ensure proper spacing and adequate surfacing area.

**Step 2:** Pour a concrete base for the component. Refer to the typical concrete slab section in this document. The concrete should be flush with the ground level. Allow time for the concrete to completely cure before continuing.

**Step 3:** Using an appropriate forklift or boom, position Unit-A into it's final installation location (See Step 3 Image).

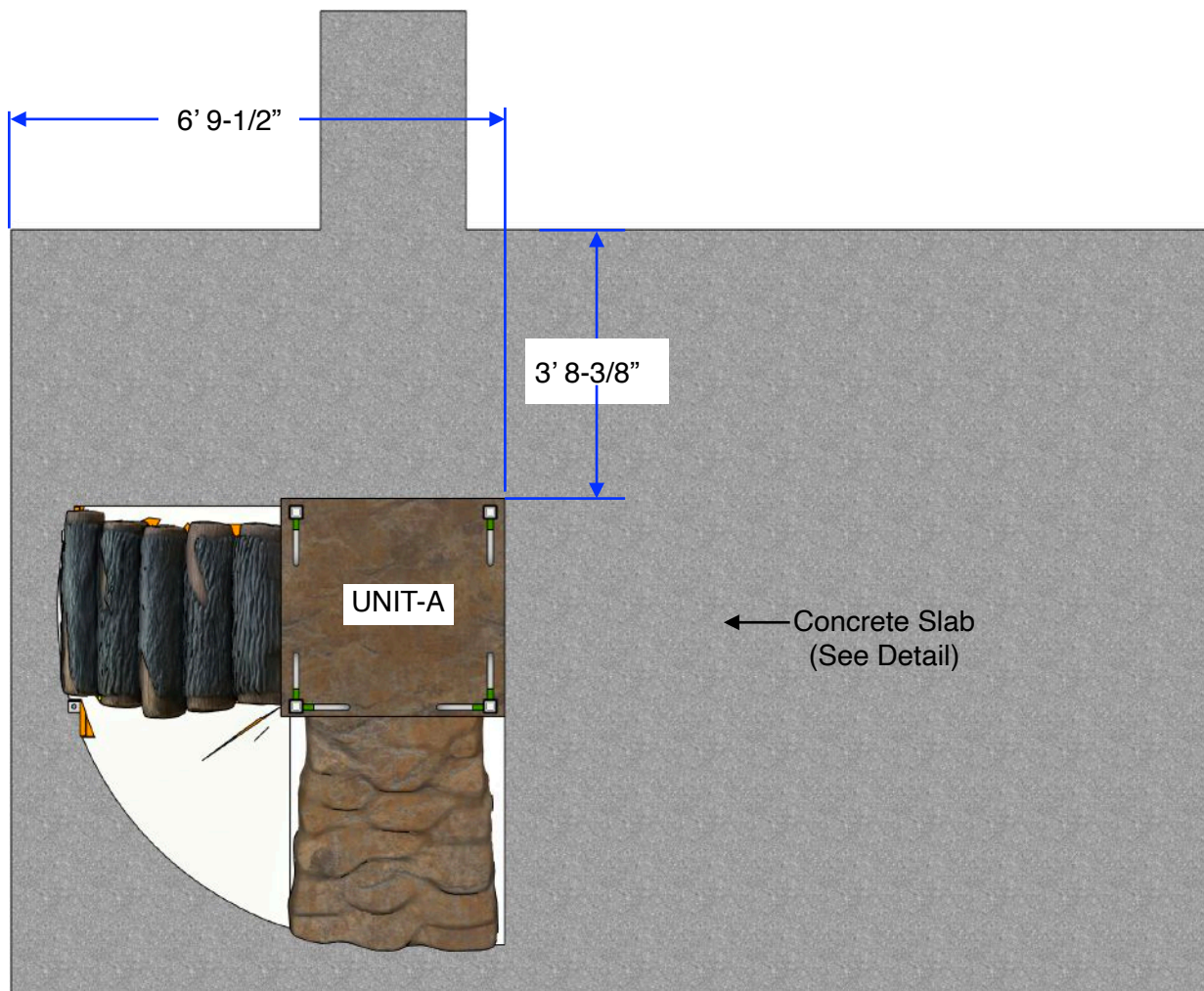

**STEP 3.**

**NOTE: Read installation instructions thoroughly before starting installation process.**

**Step 4:** Locate Unit-B. Using the supplied adhesive (hardware kit HK146), glue the foam mating end to Unit-A. With the dispensing gun fully open, dispense foam with a continuous bead. Apply the beads in rows of foam, 4 inches apart. Align Unit-A with Unit-B ensuring the seams are flush with each other.

**Step 5:** Locate Unit-C. Using the supplied adhesive (hardware kit HK146), glue the foam mating end to Unit-B. With the dispensing gun fully open, dispense foam with a continuous bead. Apply the beads in rows of foam, 4 inches apart. Align Unit-B with Unit-C ensuring the seams are flush with each other. Allow the glue to dry for 24 hours before the surfacing is

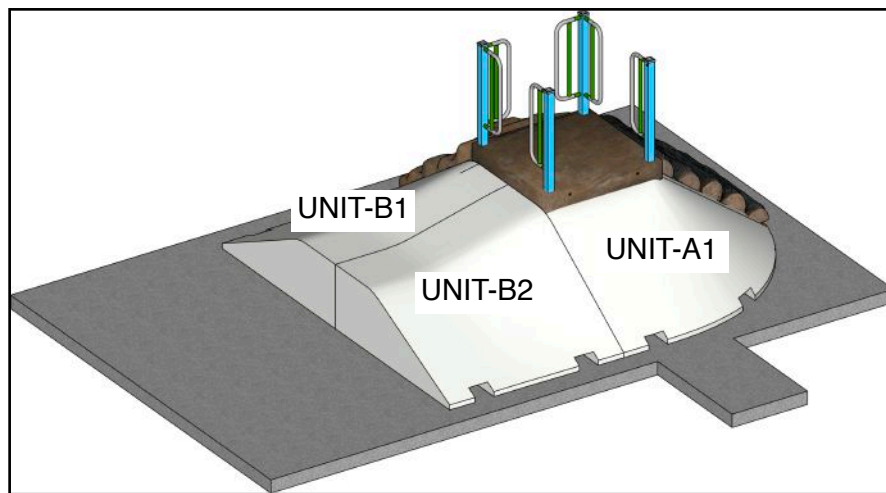

STEP 4.

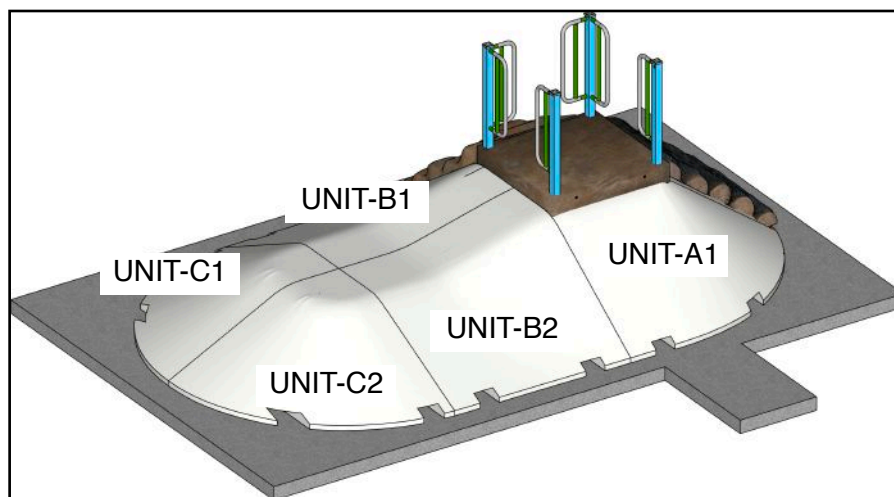

STEP 5.

**NOTE: Read installation instructions thoroughly before starting installation process.**

**Step 6:** Locate the slide bedway and slide entrance panel. Using hardware kit HK042, bolt the slide panel to the slide transition plate from the backside (2 places), see Step 6 image. Bolt the slide panel to the slide assembly using hardware kit HK074 (4 places).

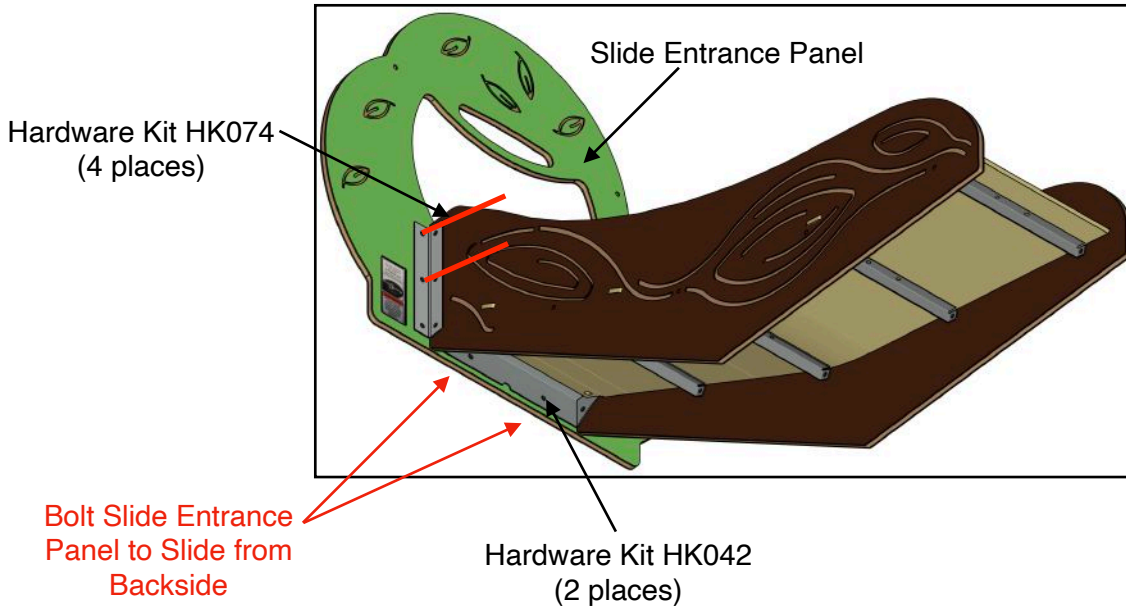

STEP 6.

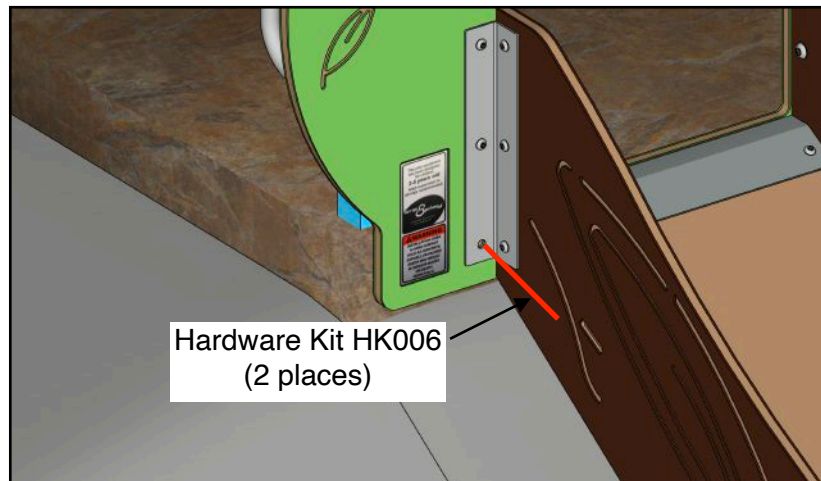

STEP 7.

**USE THREAD LOCK ON ALL FASTENERS  
CUT ANY AND ALL BOLT ENDS WITH MORE THAN 2 THREADS EXPOSED**

**NOTE: Read installation instructions thoroughly before starting installation process.**

**Step 8:** See the hardware recommendation for information on anchoring equipment down to your concrete slab.  
(See Step 8 image)

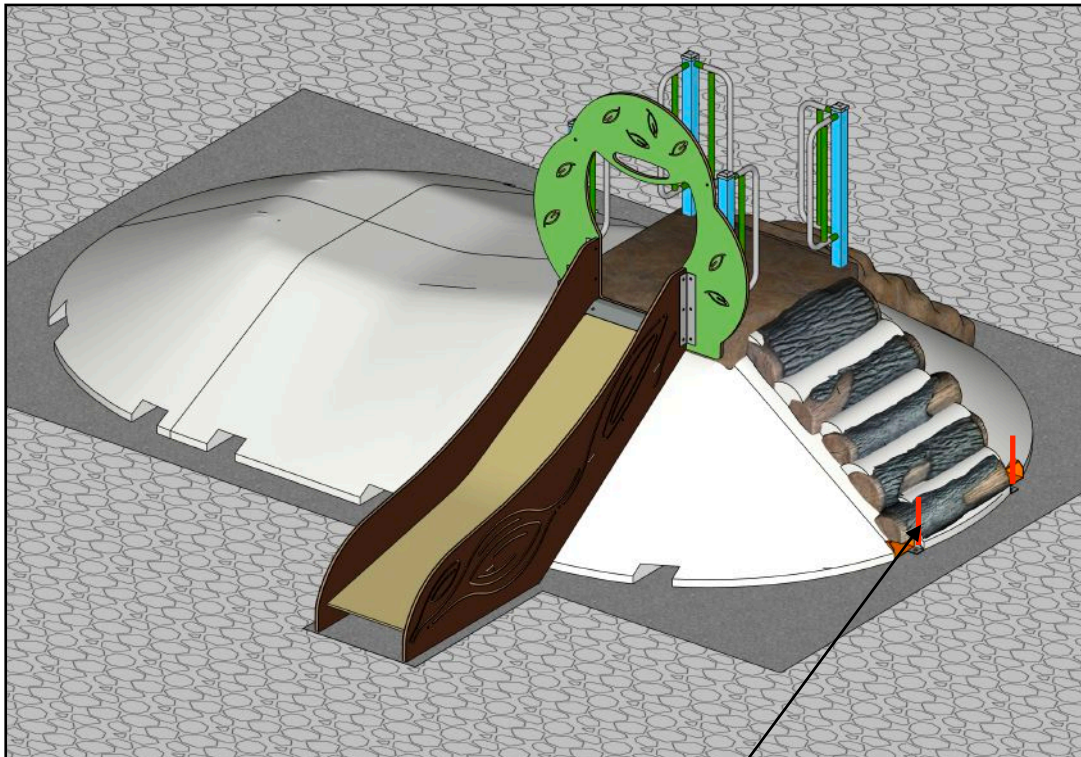

Hardware Kit HK128  
(2 places)

**STEP 8.**

**NOTE: Read installation instructions thoroughly before starting installation process.**

**Step 10:** Install the turf or PIP surfacing to the Slide Mound with approved impact attenuating play surface around the component. Refer to the surfacing manufacturer for installation of an approved impact attenuating play surface around the component with a minimum use zone in every direction.

**Step 11:** Once the surfacing is installed and cured, position the slide to Unit-A and fasten the slide assembly to the deck with hardware kit HK006 (2 places).

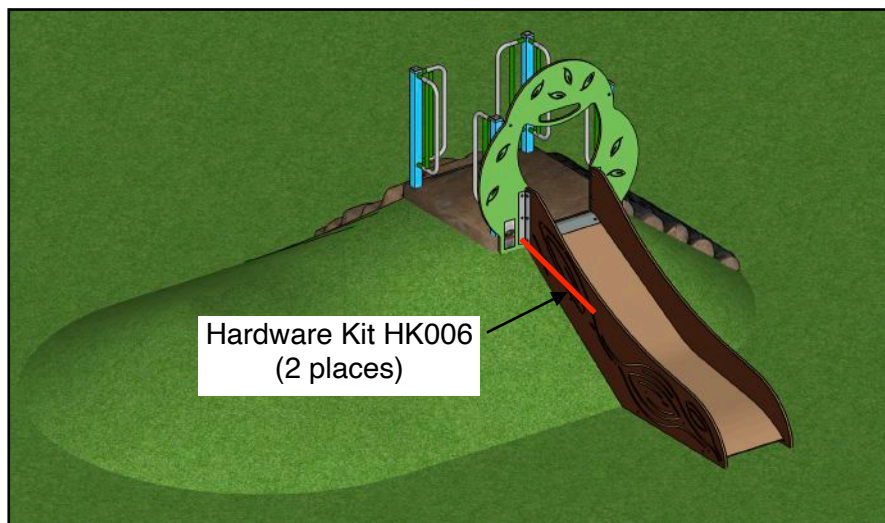

STEP 11.

**USE THREAD LOCK ON ALL FASTENERS  
CUT ANY AND ALL BOLT ENDS WITH MORE THAN 2 THREADS EXPOSED**

**NOTE: Read installation instructions thoroughly before starting installation process.**

**Step 12:** Using hardware kit HK142, fasten the VP-1015 post brackets to the post in 2 places.

**Step 13:** Using hardware kit HK003, fasten the VP-1015 post brackets to the slide panel in 2 places. Install the barrel nut on the plastic panel side. (See Step 12 & 13 image)

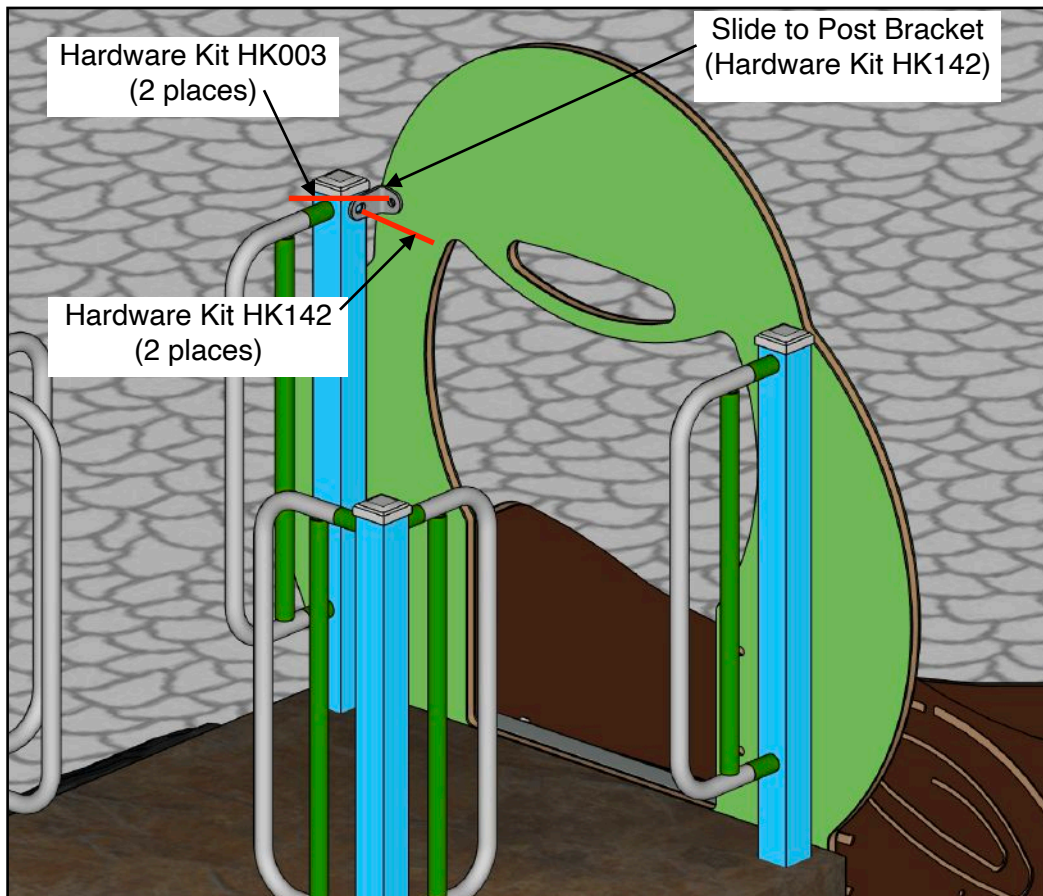

STEPS 12 & 13

**USE THREAD LOCK ON ALL FASTENERS  
CUT ANY AND ALL BOLT ENDS WITH MORE THAN 2 THREADS EXPOSED**

**Included Items:**

Part #	Item	Description	Quantity
1000318	Play Mound Unit-A	Play Equipment	2
1000318	Play Mound Unit-B	Play Equipment	2
1000318	Play Mound Unit-C	Play Equipment	2
1000318	Slide Bedway	Play Equipment	1
1000318	Slide Entrance Panel	Play Equipment	1

**Step 1: Drill**

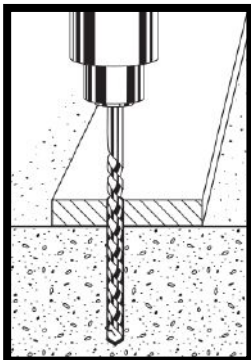

**Step 2: Anchor**

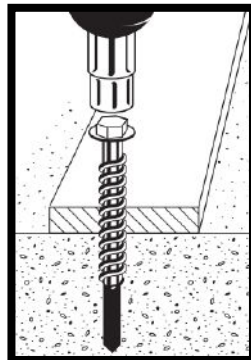

**Anchor Bolt Installation:**

Anchor Bolt Size	ANSI Standard Drill Bit Diameter	Anchor Head (Socket Size)	Minimum Embedment	Hole Depth
1/2" x 3"	7/16"	3/4"	2 1/2"	3 1/2"
5/8" x 4"	1/2"	13/16"	3 1/2"	4 1/2"
5/8" x 6"	1/2"	13/16"	5 1/2"	6 1/2"

**NOTE: Always wear eye protection appropriate to the task at hand.**

**Included Items:**

Item	Hardware Kit #	Quantity
3/8" X 2" BUTTON HEAD, PIN-IN, SS BOLT	Hardware Kit HK042	2
3/8" FLAT WASHER, SS	Hardware Kit HK042	4
3/8" NYLOCK NUT, SS	Hardware Kit HK042	2
1/2" x 3" TAPCON LTD FASTENER	Hardware Kit HK128	2
3/8" X 1 3/4" BUTTON HEAD, PIN-IN, SS BOLT	Hardware Kit HK006	2
3/8" FLAT WASHER, SS	Hardware Kit HK006	2
3/8" SPLIT LOCK WASHER, SS	Hardware Kit HK006	2
3/8" X 1-1/4" BUTTON HEAD, PIN-IN, SS BOLT	Hardware Kit HK142	2
3/8" FLAT WASHER, SS	Hardware Kit HK142	2
3/8" SPLIT LOCK WASHER, SS	Hardware Kit HK142	2
VP1015 - POST BRACKET	Hardware Kit HK142	2
3/8" X 1" BUTTON HEAD, PIN-IN, SS BOLT	Hardware Kit HK003	2
3/8" FLAT WASHER, SS	Hardware Kit HK003	2
3/8" SPLIT LOCK WASHER, SS	Hardware Kit HK003	2
GREAT STUFF PRO ADHESIVE	Hardware Kit HK146	1
ADHESIVE DISPENSING GUN	Hardware Kit HK146	1
3/8" X 1" BUTTON HEAD, PIN-IN, SS BOLT	Hardware Kit HK074	4
3/8" FLAT WASHER, SS	Hardware Kit HK074	4
3/8" SPLIT LOCK WASHER, SS	Hardware Kit HK074	4
3/8" x 7/16" BARREL NUT, SS	Hardware Kit HK074	4
LOCTITE THREAD LOCK (RED), small	None	1